

# Encore!<sup>TM</sup> Symmetry

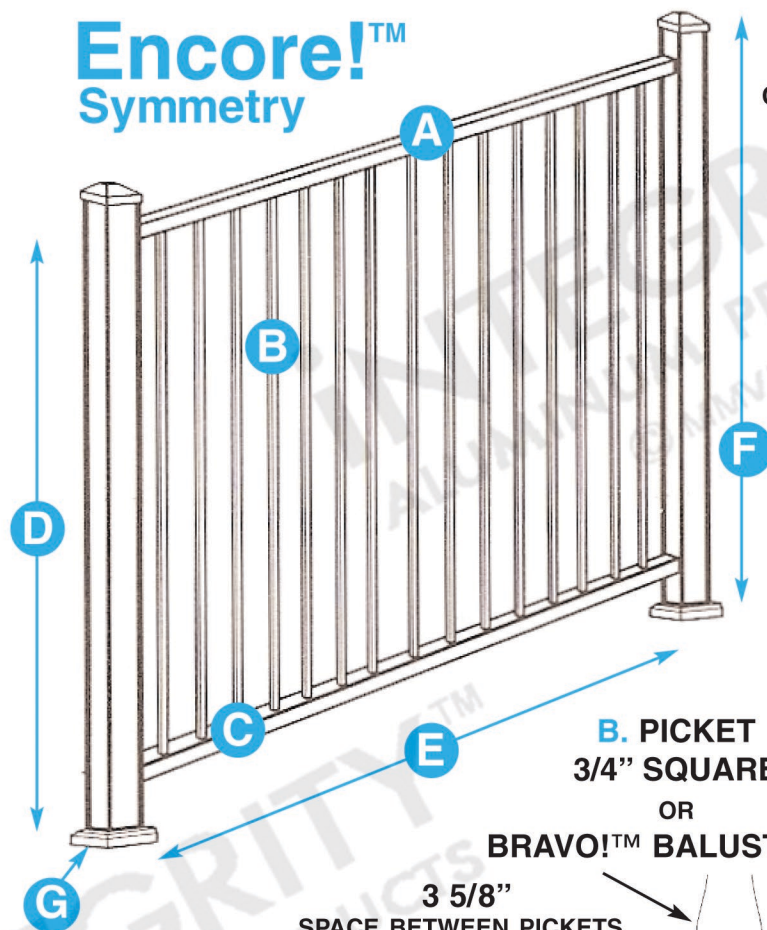

**A. TOP RAIL PROFILES**  
CONCEALED FASTENER SYSTEM

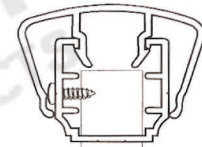

**PRELUDE<sup>TM</sup>**  
2 1/4" x 1 5/8"

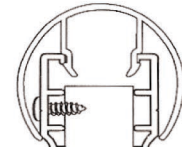

**CONCERTO<sup>TM</sup>**  
2" x 1 5/8"

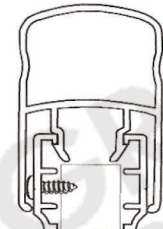

**CANTATA<sup>TM</sup>**  
1 3/4" x 2 1/2"

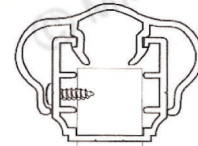

**SONATA<sup>TM</sup>**  
2 1/4" x 1 5/8"

**B. PICKET**  
3/4" SQUARE  
OR  
**BRAVO!<sup>TM</sup> BALUSTER**

3 5/8"  
SPACE BETWEEN PICKETS



**D. PANEL HEIGHT**  
36" or 42"  
NOMINAL (OFF GRADE)

**E. PANEL WIDTH**  
6' or 8'

**C. LOWER RAIL**  
1 3/8" x 1 1/4"  
CFS

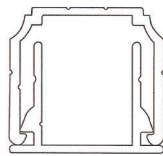

**G. BOSS SCREW FLANGE**

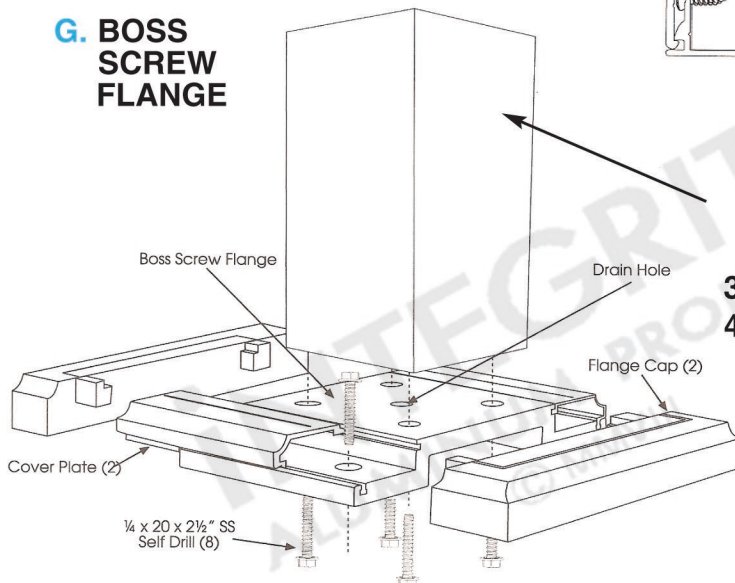

**F. BOSS SCREW POST**  
2 1/2" SQUARE  
.100" WALLS  
37" OR 47" FOR 36" PANEL  
43" OR 53" FOR 42" PANEL  
POST CAPS INCLUDED

